









Zeus Appollo™ Polycrystalline PV Modules

-  **High cell efficiency**
Superior cell technology and leading manufacturing capability, high economic benefits for customers
-  **Positive output tolerance**
Guaranteed positive tolerance of up to 3% delivers higher outputs, ensuring a greater return on your investment
-  **Infrared and EL tested**
Passed Electroluminescence inspection, detecting cracks and other imperfections unseen by the naked eye
-  **Bypass diodes**
Minimize the power drop caused by shade, increase tolerance to shade and maximize output

-  **Anti-reflective Glass**
Higher module efficiency from anti-reflective, hydrophobic layer with higher light absorption and minimal surface dust
-  **CEC Approved, Fire Rated and Tested & TUV European approved**
Rigorous quality control meeting the highest international standards
-  **Near Linear Performance Warranty for 25 years**
No less than 97% of nominal output power in the first year, no more than 0.7% annual decline based on nominal output power after the second year, 25-year warranty at 80.2% of nominal output power
-  **Local stock & local support**
Quick response, service and no fuss warranty replacement

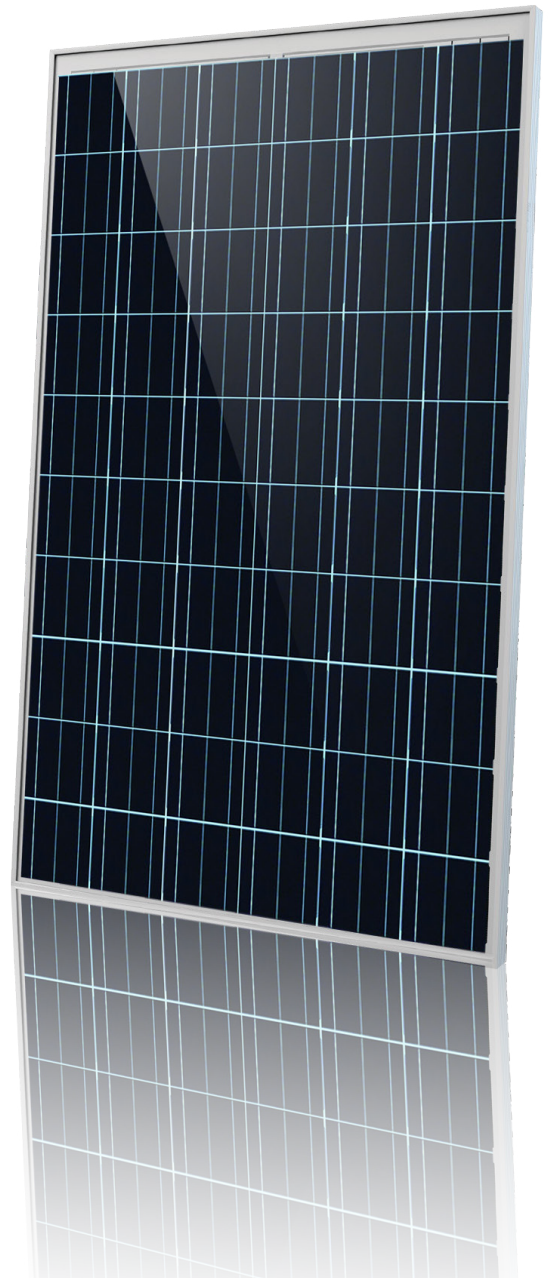

Manufactured in China and imported by:
Beijing Hua Xin Liu He Investment (Australia) Pty Ltd
WA Office: 789 Wellington Street, West Perth, WA 6005, Australia
Tel: +61-8-6311 9906
QLD Office: 32 Crockford Street, Banyo, QLD 4014, Australia
Tel: +61-7-3123 6148, Fax: +61-7-3266 4758



POLYCRYSTALLINE SOLAR MODULE ZA1ZDNY260W



Typical electrical characteristics

Characteristics	ZA1ZDNY- 260P60
Max. Power (PMax)	260W
Optimum Operating Voltage(Vm)	30.73V
Optimum Operating Current(Im)	8.47A
Open-circuit Voltage (Voc)	37.90V
Short-circuit Current (Isc)	9.01A
Cell Efficiency	18.13%

The specifications are obtained under the Standard Test Condition (STC):
1000W/m² solar irradiance, AM1.5, Cell Temperature 25°C

Solar Cell	Poly-crystalline 156x156 mm
Output Tolerance (PMax)	0~+3%
Number of Cells	60 cells in series
Module Dimension	1640x992x40mm
Weight	18.2kg
Max. System Voltage	1500V(TUV)
Max. Series Fuse Rating	15A
Output Cable / Connector Type	PV 4mm ² / PV-GZX
Cable Length	90cm±5
Temperature Cycling Range	(-40~85°C)
NOCT	47°C±2°C
Temperature Coefficients of Isc	+(0.053±0.01)%/K
Temperature Coefficients of Voc	-(0.35±0.001)%/K
Temperature Coefficients of PMax	-(0.40±0.05)%/K

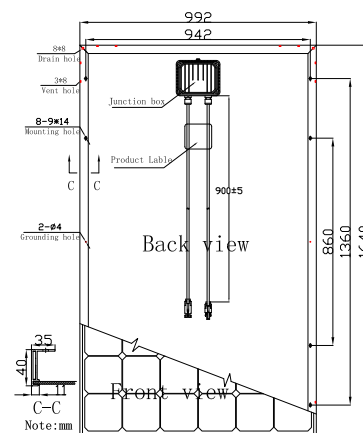

I-V Curves of PV module ZA1ZDNY-260P60 at various cell temperatures

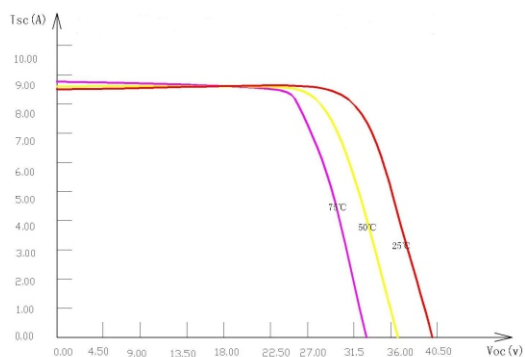

I-V Curves of PV module ZA1ZDNY-260P60 at various solar irradiance

